

Varenummer: 03445045
Beskrivelse: Fluro Heavy Duty Ledleje GE 45 EW-2RS
Hul Ø45
Note: 45

Mål

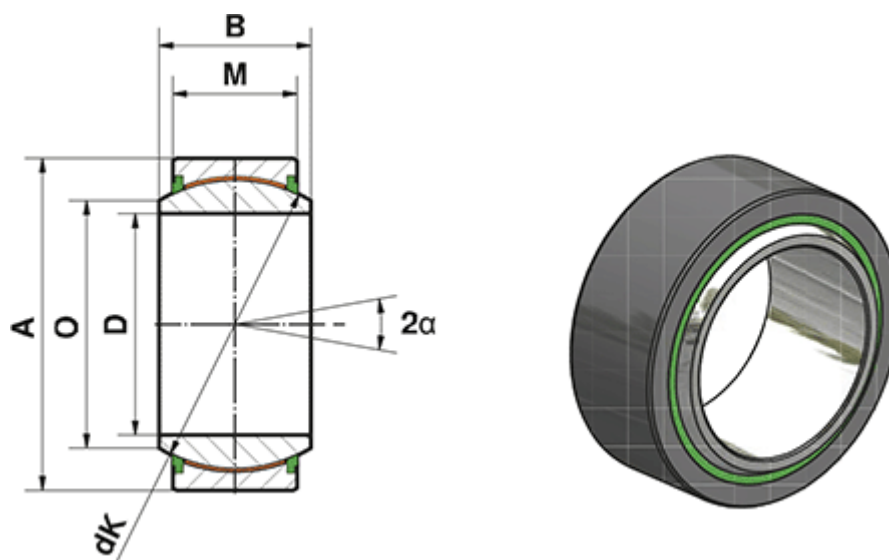

A	= 68	Statisk belastning C0 (kN) = 600
a (grader)	= 7	Vægt (g) = 390
B	= 32	
D	= 45	
dK	= 60	
Dynamisk belastning C (kN)	= 360	
M	= 25	
O	= 50.7	